

VENTS FB K2 SERIES

Sound-insulated centrifugal fans with filters



MOUNTING

- The compact design offers the ideal mounting solutions for limited mounting space, including suspended ceiling mounting. Wall or ceiling mounting is performed by means of the supplied mounting brackets. Filters can be installed in any position.

AIR FILTRATION

- Built-in filters provide efficient air filtration. Up to three filters can be installed into the casing.
- MERV8 filter provides primary filtration. At the second stage, the secondary filter MERV14 or HEPA filter H13 (HEPA type C) can be installed. MERV14 filter arrests up to 98 % of PM 2.5 dust particles. HEPA Filter H13 (HEPA type C) arrest up to 99 % of PM 2.5 dust particles, pollen and bacteria. For additional removal of unwanted odours and gases, it is possible to install a carbon filter. The casing incorporates a service panel for quick access to the filters.

FEATURES

- The best ventilation solution for premises with high requirements to clean air and the noise level. Filters are designed for use in supply ventilation and conditioning systems.
- Compatible with Ø 4" up to 8" round air ducts.
- Suitable for limited mounting space.

DESIGN

- Corrosion resistant casing made of polymer coated steel. Easy access for filter replacement.

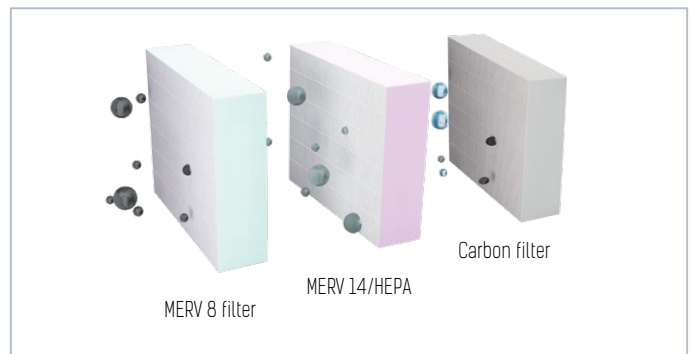

DESIGNATION KEY

Series	Spigot diameter	Filters
FB K2	100 - 4" 125 - 5" 150 - 6" 200 - 8"	G4/F8: MERV8 + MERV14 G4/F8/C: MERV8 + CARBON + MERV 14 G4/H13: MERV8 + HEPA type C G4/H13/C: MERV8 + HEPA type C+ Carbon

OVERALL DIMENSIONS [IN]

Model	ØD	L	H	B	L1	B1	L2	B2	Weight [lb]
FB 100 K2 (G4/F8)	4		9 3/4	16 1/4		20		18	16,5
FB 100 K2 (G4/F8/C)									18
FB 100 K2 (G4/H13)									16,5
FB 100 K2 (G4/H13/C)									18
FB 125 K2 (G4/F8)	4 7/8		9 3/4	16 1/4		20		18	16,5
FB 125 K2 (G4/F8/C)									18
FB 125 K2 (G4/H13)									16,5
FB 125 K2 (G4/H13/C)									18
FB 150 K2 (G4/F8)	5 7/8	16 1/4	11 3/4	17 3/8	20 1/4	21	14 1/6	19	18,7
FB 150 K2 (G4/F8/C)									19,9
FB 150 K2 (G4/H13)									18,7
FB 150 K2 (G4/H13/C)									19,9
FB 200 K2 (G4/F8)	7 7/8		11 3/4	23 7/8		27 1/2		25 1/2	23,4
FB 200 K2 (G4/F8/C)									26,1
FB 200 K2 (G4/H13)									23,4
FB 200 K2 (G4/H13/C)									26,1

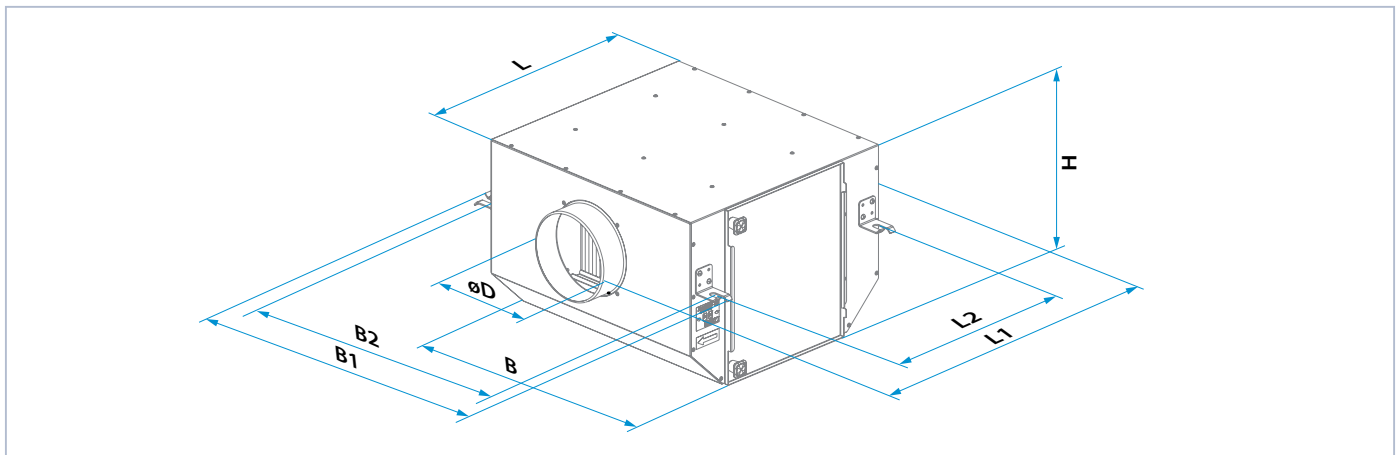

ACCESSORIES

Name	Image	FB 100 K2	FB 125 K2	FB 150 K2	FB 200 K2
Panel filter MERV8		FP 220x400x47 G4	FP 220x400x47 G4	FP 270x425x47 G4	FP 270x590x47 G4
Panel filter MERV14		FP 220x400x47 F8	FP 220x400x47 F8	FP 270x425x47 F8	FP 270x590x47 F8
HEPA type C Panel filter		FP 220x400x47 H13	FP 220x400x47 H13	FP 270x425x47 H13	FP 270x590x47 H13
Carbon panel filter		FP 220x400x47 C	FP 220x400x47 C	FP 270x425x47 C	FP 270x590x47 C

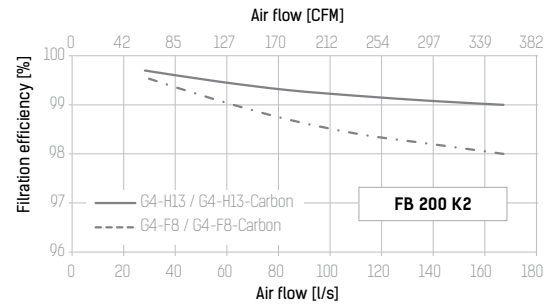
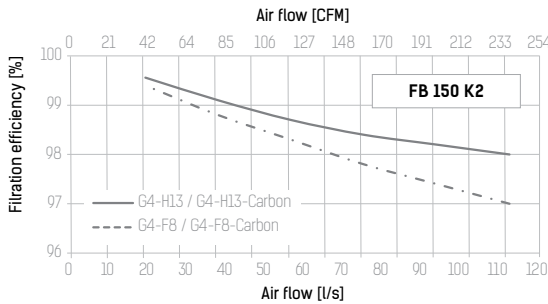
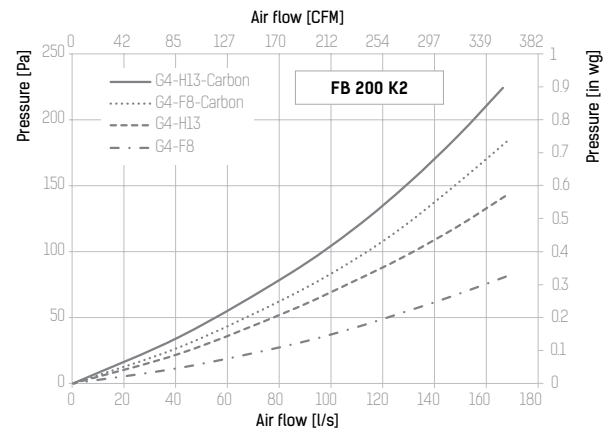
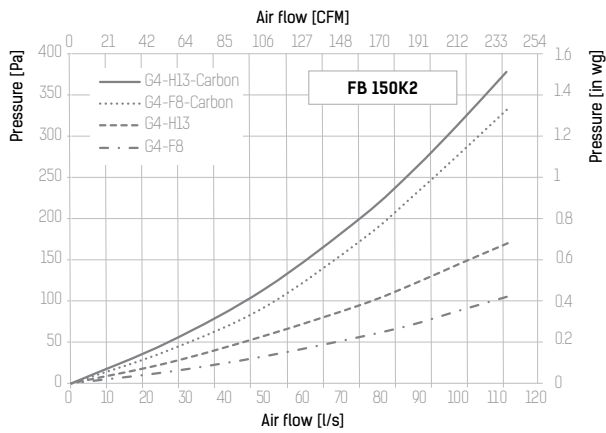
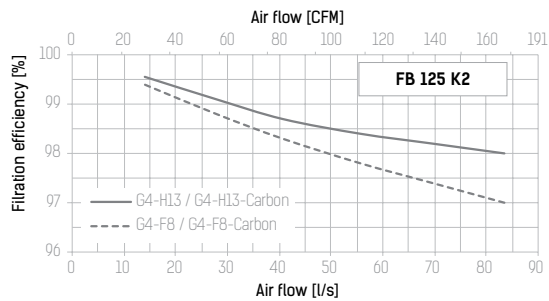
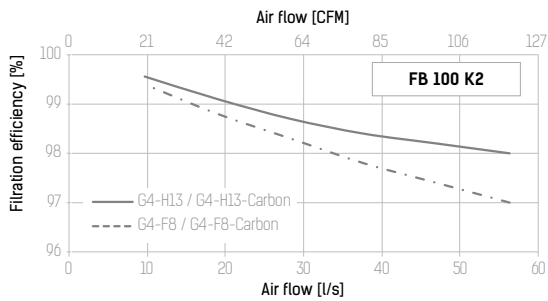
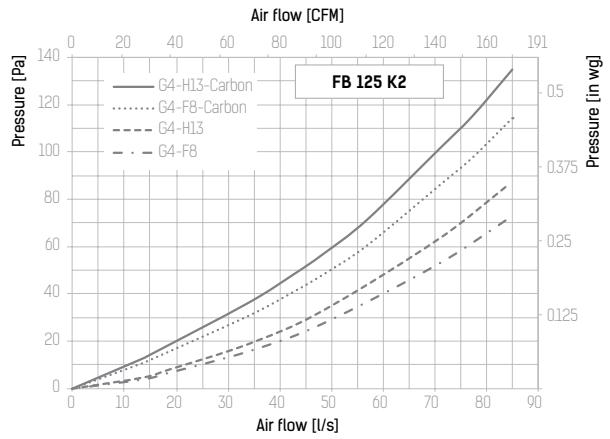
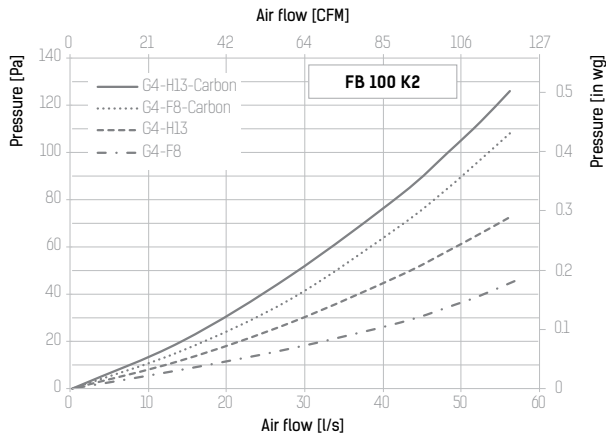
TECHNICAL DATA

APPLICATION



APPLICATION

