

VENTS KSV SERIES

Sound-insulated centrifugal fans with filters



Air flow:
up to 371 CFM



Power:
from 32 W



Noise level:
0.25 Sones



FEATURES

- Designed for integration into supply and exhaust, ventilation systems requiring high cleaning of intake air, low-noise operation and limited mounting space.
- Compatible with Ø 4" up to 8" round air ducts.

DESIGN

- The casing is made of polymer coated steel, internally lined with sound-insulating layer. Power is supplied through the terminal box inside of the casing. The fan design provides convenient maintenance access to the internal parts and filter replacement.

MOTOR

- The single-speed models are equipped with a fourpole asynchronous electric external rotor motors and centrifugal impellers with forward curved blades. The impellers are dynamically balanced. The motors are compatible with power mains frequency 60 Hz. The double-speed models (Duo) are equipped with asynchronous electric external rotor motors and centrifugal impellers with forward curved blades. Double-speed control. The ball bearings enable a long operating life. The motors are equipped with an integrated overheating protection with automatic restart. The motor protection class is IP44.

MOUNTING

- The fans are compatible with round air ducts. The use of flexible connectors requires fixation of the fan on the building structure by means of the supplied mounting brackets. The fan can be installed in any position (including suspended ceiling mounting), taking into account the air flow direction indicated by the arrow on the fan casing.

AIR FILTRATION

- Built-in filters provide efficient air filtration. Up to three filters can be installed into the casing.
- MERV8 filter provides primary filtration. At the second stage, the secondary filter MERV14 or HEPA filter H13 (HEPA type C) can be installed. MERV14 filter arrests up to 98 % of PM 2.5 dust particles. HEPA Filter H13 (HEPA type C) arrest up to 99 % of PM 2.5 dust particles, pollen and bacteria. For additional removal of unwanted odours and gases, it is possible to install a carbon filter. The casing incorporates a service panel for quick access to the filters.

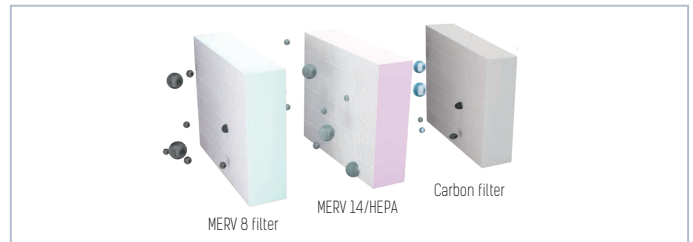

Modifications

KSV DUO: two-speed motor
KSV Q: low noise and low-powered motor

Speed control

Single-speed models: smooth speed control with the external speed controller RS-1-400 (specially ordered accessory).
Two-speed models: smooth speed control with the external speed switch P2-10 (specially ordered accessory).

DESIGNATION KEY

Series	Spigot diameter	Motor modification	Filters	Options
VENTS KSV	100 - 4' 150 - 6' 200 - 8'	Duo: two-speed motor Q: low noise and low-powered motor	G4: Only MERV8 G4/F8: MERV8 + MERV14 G4/F8/C: MERV8 + MERV 14+ coal filter G4/H13: MERV8 + HEPA type C G4/H13/C: MERV8 + HEPA type C+ Coal filter	R: 15 inch long power cable with a C14 plug RI: 15 inch long power cable with a standard electric plug

OVERALL DIMENSIONS [IN]

Model	ØD	L	H	B	L1	B1	L2	B2	Weight [lb]
KSV 100 (DUO) G4	4	27 ³ / ₄	9 ⁷ / ₈	16 ³ / ₈	31 ⁵ / ₈	20	25 ⁵ / ₈	18	30.8
KSV 100 (DUO) G4/F8									31.2
KSV 100 (DUO) G4/F8/C									32.8
KSV 100 (DUO) G4/H13									31.2
KSV 100 (DUO) G4/H13/C									32.8
KSV 150 (DUO) G4	5 ⁷ / ₈	27 ³ / ₄	9 ⁷ / ₈	16 ³ / ₈	31 ⁵ / ₈	20	25 ⁵ / ₈	18	35.1
KSV 150 (DUO) G4/F8									35.6
KSV 150 (DUO) G4/F8/C									37.7
KSV 150 (DUO) G4/H13									35.6
KSV 150 (DUO) G4/H13/C									37.7
KSV 150 (DUO) Q G4	5 ⁷ / ₈	29	11 ³ / ₄	17 ³ / ₈	32 ⁷ / ₈	21	26 ³ / ₄	19	30.8
KSV 150 (DUO) Q G4/F8									31.2
KSV 150 (DUO) Q G4/F8/C									32.8
KSV 150 (DUO) Q G4/H13									31.2
KSV 150 (DUO) Q G4/H13/C									32.8
KSV 200 (DUO) G4	7 ⁷ / ₈	29	11 ³ / ₄	23 ³ / ₄	32 ⁷ / ₈	27 ¹ / ₂	26 ³ / ₄	25 ¹ / ₂	41.3
KSV 200 (DUO) G4/F8									42.1
KSV 200 (DUO) G4/F8/C									32.7
KSV 200 (DUO) G4/H13									42.1
KSV 200 (DUO) G4/H13/C									32.8

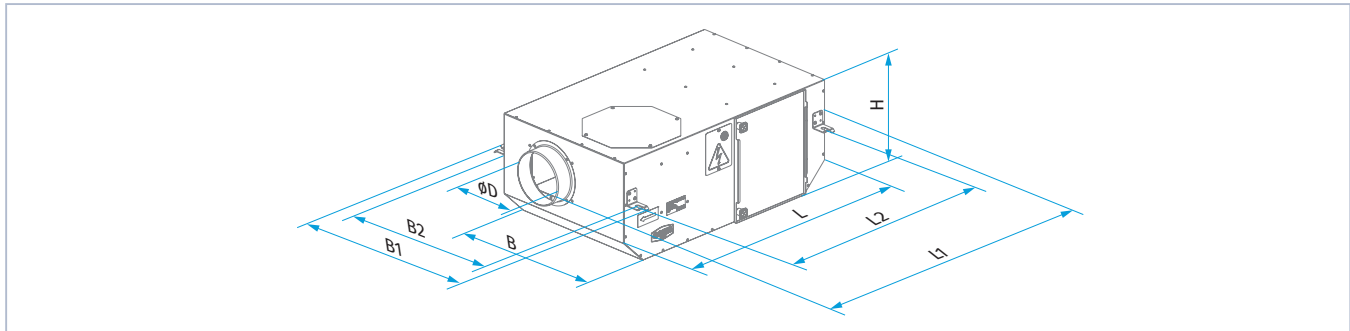

ACCESSORIES

Name	Image	KSV 100	KSV 150 Q	KSV 150	KSV 200	KSV 100 DUO	KSV 150 DUO Q	KSV 150 DUO	KSV 200 DUO
Panel filter MERV8		SF 220x400x47-G4	SF 270x425x47-G4	SF 270x590x47-G4	SF 270x590x47-G4	SF 220x400x47-G4	SF 270x425x47-G4	SF 270x590x47-G4	SF 270x590x47-G4
Panel filter MERV14		SF 220x400x47-F8	SF 270x425x47-F8	SF 270x590x47-F8	SF 270x590x47-F8	SF 220x400x47-F8	SF 270x425x47-F8	SF 270x590x47-F8	SF 270x590x47-F8
HEPA type C Panel filter		SF 220x400x47-H13	SF 270x425x47-H13	SF 270x590x47-H13	SF 270x590x47-H13	SF 220x400x47-H13	SF 270x425x47-H13	SF 270x590x47-H13	SF 270x590x47-H13
Carbon panel filter		SF 220x400x47-S	SF 270x425x47-S	SF 270x590x47-S	SF 270x590x47-S	SF 220x400x47-S	SF 270x425x47-S	SF 270x590x47-S	SF 270x590x47-S
Speed controller		PS-1-400				P2-10			

TECHNICAL DATA

Parameters	KSV 100 G4 KSV 100 G4/C	KSV 100 G4/F8 KSV 100 G4/F8/C	KSV 100 G4/H13 KSV 100 G4/H13/C
Voltage [V/50 (60) Hz]	1~ 230	1~ 230	1~ 230
Power [W]	53	53	52
Current [A]	0.27	0.27	0.27
Maximum air flow [CFM (l/s)]	112 (53)	106 (50)	100 (47)
RPM [min ⁻¹]	1300	1300	1300
Sound pressure at 10 ft [Sones (dBA)]	0.4 (23)	0.4 (23)	0.4 (23)
Transported air temperature [°F]	-13...+104	-13...+104	-13...+104
Ingress protection rating	IPX4	IPX4	IPX4
PM 2.5 Ratio [%]	36	93	98

KSV 100

Sound power level, A-weighted	General	Octave frequency band [Hz]								LpA 10 ft [dBA]	LpA 3 ft [dBA]
		63	125	250	500	1000	2000	4000	8000		
L _{wA} to inlet [dBA]	48	32	34	40	42	43	40	34	26	27	37
L _{wA} to outlet [dBA]	51	27	42	47	45	44	32	24	13	30	40
L _{wA} to environment [dBA]	43	31	34	35	38	36	34	31	26	23	33

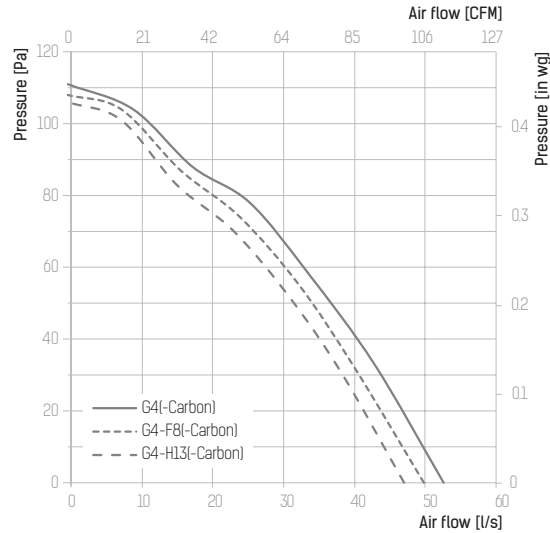

Parameters	KSV 150 Q G4 KSV 150 Q G4/C	KSV 150 Q G4/F8 KSV 150 Q G4/F8/C	KSV 150 Q G4/H13 KSV 150 Q G4/H13/C
Voltage [V/50 (60) Hz]	1~ 230	1~ 230	1~ 230
Power [W]	63	61	59
Current [A]	0.29	0.25	0.28
Maximum air flow [CFM (l/s)]	212 (100)	194 (92)	182 (86)
RPM [min ⁻¹]	1300	1300	1300
Sound pressure at 10 ft [Sones (dBA)]	0.5 (25)	0.5 (25)	0.5 (25)
Transported air temperature [°F]	-13..+104	-13..+104	-13..+104
Ingress protection rating	IPX4	IPX4	IPX4
PM 2.5 Ratio [%]	31	92	98

KSV 150 Q

Sound power level, A-weighted	General	Octave frequency band [Hz]								LpA 10 ft [dBA]	LpA 3 ft [dBA]
		63	125	250	500	1000	2000	4000	8000		
L _{wA} to inlet [dBA]	53	28	44	49	47	46	34	25	14	33	43
L _{wA} to outlet [dBA]	56	39	41	48	51	52	48	41	32	36	46
L _{wA} to environment [dBA]	45	26	35	41	39	37	34	30	23	25	35

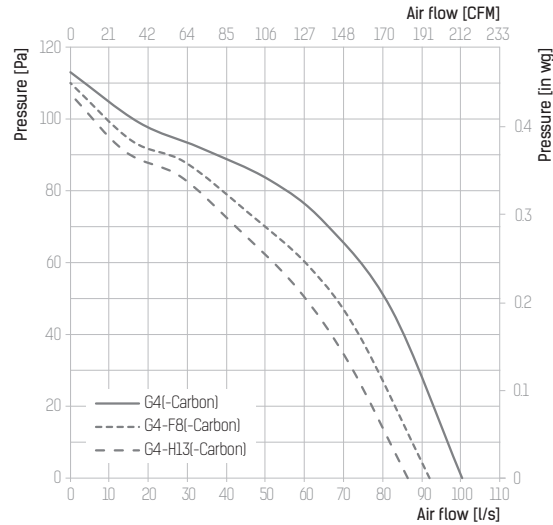

Parameters	KSV 150 G4 KSV 150 G4/C	KSV 150 G4/F8 KSV 150 G4/F8/C	KSV 150 G4/H13 KSV 150 G4/H13/C
Voltage [V/50 (60) Hz]	1~ 230	1~ 230	1~ 230
Power [W]	107	104	102
Current [A]	0.49	0.48	0.48
Maximum air flow [CFM (l/s)]	259 (122)	235 (111)	212 (100)
RPM [min ⁻¹]	1250	1250	1250
Sound pressure at 10 ft [Sones (dBA)]	0.6 (27)	0.6 (27)	0.6 (27)
Transported air temperature [°F]	-13...+104	-13...+104	-13...+104
Ingress protection rating	IPX4	IPX4	IPX4
PM 2.5 Ratio [%]	39	92	98

KSV 150

Sound power level, A-weighted	General	Octave frequency band [Hz]								LpA 10 ft [dBA]	LpA 3 ft [dBA]
		63	125	250	500	1000	2000	4000	8000		
L _{wA} to inlet [dBA]	53	39	40	47	50	41	40	38	27	33	43
L _{wA} to outlet [dBA]	58	42	39	47	54	50	51	45	35	37	47
L _{wA} to environment [dBA]	48	38	40	41	44	36	29	28	24	27	37

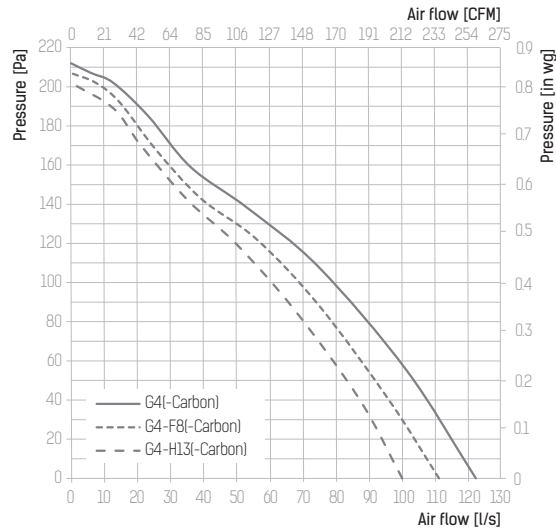

Parameters	KSV 200 G4 KSV 200 G4/C	KSV 200 G4/F8 KSV 200 G4/F8/C	KSV G4/H13 KSV G4/H13/C
Voltage [V/50 (60) Hz]	1~ 230	1~ 230	1~ 230
Power [W]	123	120	115
Current [A]	0.56	0.56	0.52
Maximum air flow [CFM (l/s)]	341 (161)	335 (158)	212 (136)
RPM [min ⁻¹]	1250	1250	1250
Sound pressure at 10 ft [Sones (dBA)]	1.8 (38)	1.8 (38)	1.8 (38)
Transported air temperature [°F]	-13..+104	-13..+104	-13..+104
Ingress protection rating	IPX4	IPX4	IPX4
PM 2.5 Ratio [%]	40	93	98
SEC class	C	C	C
ErP	2016; 2018	2016; 2018	2016; 2018

KSV 200

Sound power level, A-weighted	General	Octave frequency band [Hz]								LpA 10 ft [dBA]	LpA 3 ft [dBA]
		63	125	250	500	1000	2000	4000	8000		
L _{wA} to inlet [dBA]	67	55	56	58	60	58	59	57	55	46	56
L _{wA} to outlet [dBA]	71	58	56	68	63	61	59	55	47	50	60
L _{wA} to environment [dBA]	58	44	48	54	55	40	34	30	36	38	48

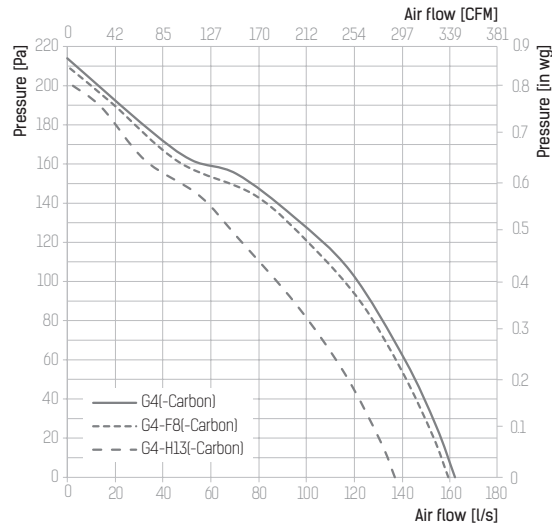

Parameters	KSV 100 Duo G4		KSV 100 Duo G4/F8 KSV 100 Duo G4/F8/C		KSV 100 Duo G4/H13 KSV 100 Duo G4/H13/C	
	min	max	min	max	min	max
Speed						
Voltage [V/50 (60) Hz]	1 ~ 230	1 ~ 230	1 ~ 230	1 ~ 230	1 ~ 230	1 ~ 230
Power [W]	34	42	33	41	32	41
Current [A]	0.15	0.19	0.15	0.19	0.15	0.19
Maximum air flow [CFM (l/s)]	94 (44)	112 (53)	88 (42)	103 (49)	82 (39)	94 (44)
RPM [min ⁻¹]	700	1200	700	1200	700	1200
Sound pressure at 10 ft [Sones (dBA)]	0.25 (14)	0.4 (23)	0.25 (14)	0.4 (23)	0.25 (14)	0.4 (23)
Transported air temperature [°F]	-13...+104	-13...+104	-13...+104	-13...+104	-13...+104	-13...+104
Ingress protection rating	IPX4	IPX4	IPX4	IPX4	IPX4	IPX4
PM 2.5 Ratio [%]	35	31	94	93	99	98

KSV 100 DUO

Sound power level, A-weighted	General	Octave frequency band [Hz]								LpA 10 ft [dBA]	LpA 3 ft [dBA]	
		63	125	250	500	1000	2000	4000	8000			
min	L _{WA} to inlet [dBA]	41	26	28	33	35	36	33	28	22	20	30
	L _{WA} to outlet [dBA]	43	22	35	39	37	37	27	20	11	23	33
	L _{WA} to environment [dBA]	35	23	26	26	29	27	26	23	20	14	24
max	L _{WA} to inlet [dBA]	48	32	34	40	42	43	40	34	26	27	37
	L _{WA} to outlet [dBA]	51	27	42	47	45	44	32	24	13	30	40
	L _{WA} to environment [dBA]	43	31	34	35	38	36	34	31	26	23	33

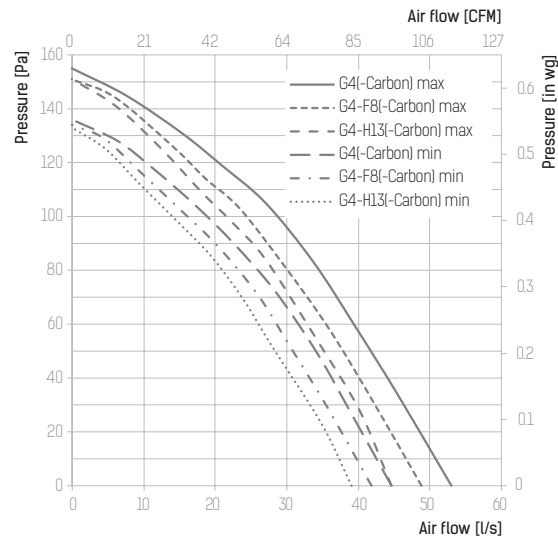

Parameters	KSV 150 Duo Q G4 KSV 150 Duo Q G4/C		KSV 150 Duo Q G4/F8 KSV 150 Duo Q G4/F8/C		KSV 150 Duo Q G4/H13 KSV 150 Duo Q G4/H13/C	
	min	max	min	max	min	max
Speed						
Voltage [V/50 (60) Hz]	1~ 230	1~ 230	1~ 230	1~ 230	1~ 230	1~ 230
Power [W]	44	52	41	50	40	48
Current [A]	0.19	0.23	0.18	0.22	0.18	0.21
Maximum air flow [CFM (l/s)]	135 (64)	200 (94)	127 (60)	182 (86)	121 (57)	168 (79)
RPM [min ⁻¹]	700	1200	700	1200	700	1200
Sound pressure at 10 ft [Sones (dBA)]	0.27 (15)	0.5 (25)	0.27 (15)	0.5 (25)	0.27 (15)	0.5 (25)
Transported air temperature [°F]	-13...+104	-13...+104	-13...+104	-13...+104	-13...+104	-13...+104
Ingress protection rating	IPX4	IPX4	IPX4	IPX4	IPX4	IPX4
PM 2.5 Ratio [%]	31	23	90	87	93	92

KSV 150 DUO Q

Sound power level, A-weighted		General	Octave frequency band [Hz]								LpA 10 ft [dBA]	LpA 3 ft [dBA]
			63	125	250	500	1000	2000	4000	8000		
min	L _{WA} to inlet [dBA]	45	24	37	41	39	38	28	21	11	25	35
	L _{WA} to outlet [dBA]	48	32	34	40	42	43	40	34	26	27	37
	L _{WA} to environment [dBA]	36	20	26	31	29	28	26	23	17	15	25
max	L _{WA} to inlet [dBA]	53	28	44	49	47	46	34	25	14	33	43
	L _{WA} to outlet [dBA]	56	39	41	48	51	52	48	41	32	36	46
	L _{WA} to environment [dBA]	45	26	35	41	39	37	34	30	23	25	35

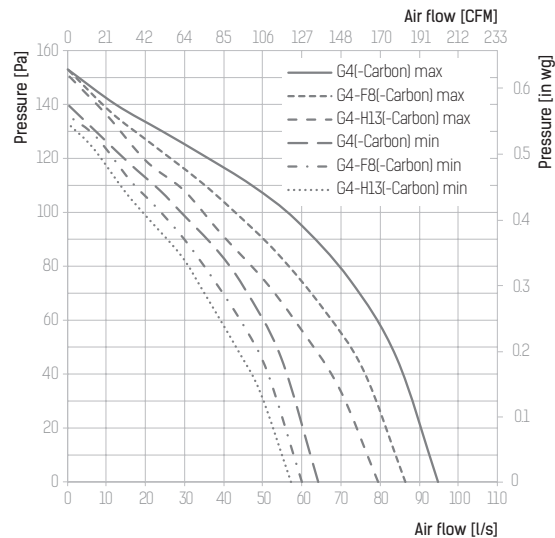

Parameters	KSV 150 Duo G4 KSV 150 Duo G4/C		KSV 150 Duo G4/F8 KSV 150 Duo G4/F8/C		KSV 150 Duo G4/H13 KSV 150 Duo G4/H13/C	
	min	max	min	max	min	max
Speed						
Voltage [V/50 (60) Hz]	1 ~ 230	1 ~ 230	1 ~ 230	1 ~ 230	1 ~ 230	1 ~ 230
Power [W]	92	117	89	115	85	114
Current [A]	0.41	0.55	0.41	0.55	0.38	0.54
Maximum air flow [CFM (l/s)]	188 (89)	253 (119)	177 (83)	230 (108)	165 (78)	209 (99)
RPM [min ⁻¹]	700	1200	700	1200	700	1200
Sound pressure at 10 ft [Sones (dBA)]	0.29 (16)	0.6 (27)	0.29 (16)	0.6 (27)	0.29 (16)	0.6 (27)
Transported air temperature [°F]	-13...+104	-13...+104	-13...+104	-13...+104	-13...+104	-13...+104
Ingress protection rating	IPX4	IPX4	IPX4	IPX4	IPX4	IPX4
PM 2.5 Ratio [%]	47	41	95	94	98	96

KSV 150 DUO

Sound power level, A-weighted		General	Octave frequency band [Hz]								LpA 10 ft [dBA]	LpA 3 ft [dBA]
			63	125	250	500	1000	2000	4000	8000		
min	L _{WA} to inlet [dBA]	44	31	32	38	41	33	32	31	22	24	34
	L _{WA} to outlet [dBA]	48	34	32	38	44	41	41	36	28	28	38
	L _{WA} to environment [dBA]	36	27	29	30	32	26	21	20	17	16	26
max	L _{WA} to inlet [dBA]	53	39	40	47	50	41	40	38	27	33	43
	L _{WA} to outlet [dBA]	58	42	39	47	54	50	51	45	35	37	47
	L _{WA} to environment [dBA]	48	38	40	41	44	36	29	28	24	27	37

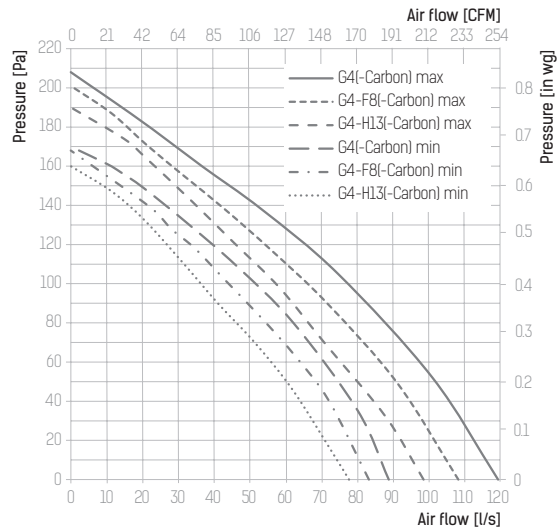

Parameters	KSV 200 Duo G4 KSV 200 Duo G4/C		KSV 200 Duo G4/F8 KSV 200 Duo G4/F8/C		KSV 200 Duo G4/H13 KSV 200 Duo G4/H13/C	
	min	max	min	max	min	max
Speed						
Voltage [V/50 (60) Hz]	1~ 230	1~ 230	1~ 230	1~ 230	1~ 230	1~ 230
Power [W]	106	123	103	121	97	119
Current [A]	0.47	0.59	0.45	0.57	0.43	0.55
Maximum air flow [CFM (l/s)]	230 (108)	371 (175)	224 (106)	347 (164)	206 (97)	309 (146)
RPM [min ⁻¹]	700	1200	700	1200	700	1200
Sound pressure at 10 ft [Sones (dBA)]	0.4 (22)	1.8 (38)	0.4 (22)	1.8 (38)	0.4 (22)	1.8 (38)
Transported air temperature [°F]	-13...+104	-13...+104	-13...+104	-13...+104	-13...+104	-13...+104
Ingress protection rating	IPX4	IPX4	IPX4	IPX4	IPX4	IPX4
PM 2.5 Ratio [%]	37	28	98	97	99	98

KSV 200 DUO

Sound power level, A-weighted		General	Octave frequency band [Hz]								LpA 10 ft [dBA]	LpA 3 ft [dBA]
			63	125	250	500	1000	2000	4000	8000		
min	L _{WA} to inlet [dBA]	55	44	45	47	48	47	48	46	44	35	45
	L _{WA} to outlet [dBA]	58	46	45	54	51	49	47	44	38	37	47
	L _{WA} to environment [dBA]	43	31	34	38	39	28	24	21	25	22	32
max	L _{WA} to inlet [dBA]	67	55	56	58	60	58	59	57	55	46	56
	L _{WA} to outlet [dBA]	71	58	56	68	63	61	59	55	47	50	60
	L _{WA} to environment [dBA]	58	44	48	54	55	40	34	30	36	38	48

