

DESCRIPTION

VENTS VKM inline centrifugal duct fans are designed for residential and commercial ventilation applications. The fan's housing is made of steel with polymer coating. The quiet and efficient backward curved impeller is capable of operating in high pressure systems. In-line configuration simplifies installation. All VKM models are designed for standard diameter round ducting. VENTS VKM inline duct fans can eliminate many ventilation problems. They are designed to boost airflow through long or complex duct runs and provide ideal solutions for residential and commercial applications. VENTS VKM sizes range from 4" to 18" with airflows ranging up to 3716 CFM. The VKM series fans are specifically for simple installation and maintenance free operation.

CASING

Fans have a housing made of steel with polymer coating.

MOTOR

Motors are supplied with automatic reset thermal protection and are equipped with ball bearings for longer service life (40,000 hrs). Suitable for air stream temperature from -13 °F to 105 °F.

SUITABLE FOR:

Bathroom exhaust; kitchen ventilation; living area; whole house ventilation; workshops & smoking areas; offices; bars & restaurants; warehouses; duct boosting.

DIMENSIONS

Model	Measurements [in.]								Duct dia
	Ø D	Ø D1	B	B1	L	L1	L2	L3	
VKM 200	7 7/8"	13 9/16"	15 3/8"	13 3/4"	9 7/8"	1"	1 1/8"	1 9/16"	8"

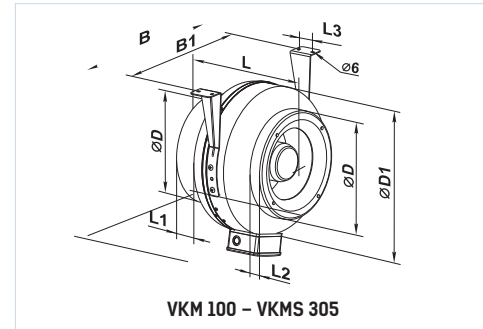
PERFORMANCE

Model	Duct Dia.	Energy Star Compliant	Current* [Amp]	Power* [W]	Sones	RPM*	Max. Ps	CFM vs. Static Pressure [Ps] in.W.G.											Volt/Hz
								0"	0.1"	0.2"	0.3"	0.4"	0.5"	0.6"	0.7"	0.8"	0.9"	1"	
VKM 200	8"	No	1.72	201	4.6	2335	2.8	599	566	530	482	440	405	372	337	310	284	261	120/60

* The parameters RPM, Watts, Amps are indicated at 0.2 in WG static pressure.

MODEL	QUANTITY	COMMENTS	PROJECT
			location:
			architect:
			engineer:
			contractor:
			submitted by: