

VKP 125



VKP/VKPF fans are specially designed for extract and input ventilation and are perfect air movement solution for areas with tight spaces

- Motor type: AC
- Impeller type: Centrifugal backward curved blades
- Casing material: Coated steel
- Installation in any position
- Sound pressure level LpA at 10 ft: 4.2

	Unit of measurement	VKP 125
Connected air duct size	in	5"
Speed	-	1
Minimum supply voltage	V	120
Maximum supply voltage	V	120
Power supply frequency	Hz	60
Rated power	W	66
Maximum unit current	A	0.54
Maximum performance @0.1"	CFM	211
Ingress protection rating	-	IPX4
Sound pressure level LpA at 10 ft	Sones	4.2

Dimensions

ØD	ØD1	A	L	B	H
5"	5"	19 31/64"	16 3/16"	12 3/16"	7 1/2"

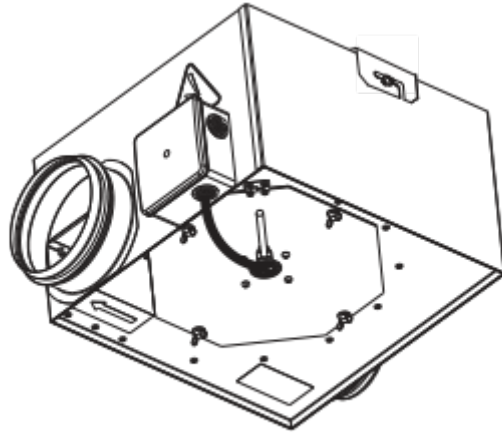

Inline dryer booster fan

